

Article number: 20273004

Description: E+G
Indexing plunger GN 822-7-C-ST

Measures

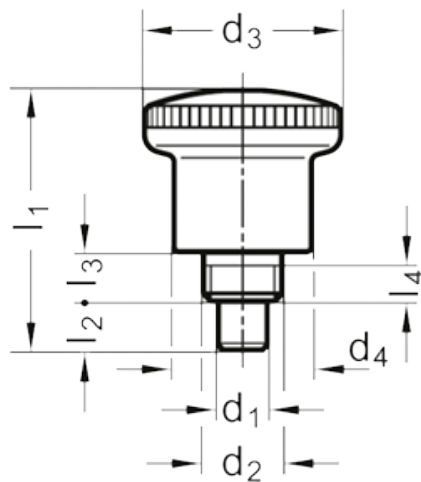

6 indexing positions

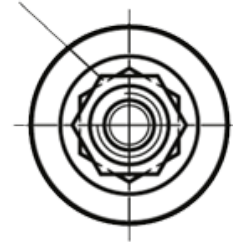

Type C
(Knob rotated by 30°)

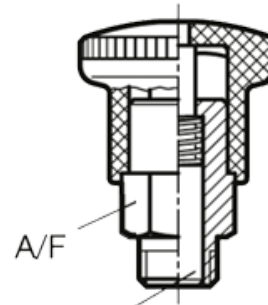

Plunger pin
retracted

A/F	= 12	l4 min.	= 4.5
d1	= 7	Spring load end	= 18
d2	= M 10 x 1	Spring load initial	= 5
d3	= 25	Weight in (g)	= 26
d4	= 18		
l1	= 34		
l2 min.	= 7		
l3	= 7		